



Inclusive Communities

# Reimagining Age-friendly Living

**BDP.**  
**Quadrangle**

**human**—space



## Covid-19

This report has been authored during the global pandemic of 2020-21, a time which has seen huge numbers of older people within our communities lose their lives to the virus. The global pandemic has highlighted the interconnections between our housing and built environment, social inequalities, and governance systems while also demonstrating the adaptability and resilience of communities across the world.

While attentions are focused on the present health crisis, this is also a time when resources are being invested heavily in public wellbeing and businesses are pivoting to reinvent themselves in the midst of quickly changing markets and technological advancements.

As we move towards recovery, there have been commitments made by many governments to “Build Back Better”, with the emphasis on a greener, more equitable recovery. This report aims to contribute to the discussion of a recovery framework.

# age-friendly vision

By transforming underutilized sites into vibrant age-friendly homes and communities, we have an enormous opportunity to revitalize our urban centres into inclusive, multi-generational neighbourhoods that nurture purposeful and fulfilling lives for people of all ages.

## This report addresses:

- The design of high quality, age-friendly homes
- Urban intensification strategies
- The creation of multi-generational communities

There is much discussion around the benefits of creating age-friendly homes that enable people to age in place and, in doing so, help to relieve pressures on health and social care systems. We also recognize that 'old age' has changed beyond recognition over the course of a generation: not only are people living longer, they are also far more diverse than previous generations in their aspirations, social attitudes, work patterns, active lifestyles, and use of technology.

Despite strong and growing demand for high quality, age-friendly homes, developers and housing providers continue to face challenges in delivering developments that are attractive, resilient, well-connected, and financially viable.

We are in a strong position to address these challenges. Our multi-disciplinary expertise and experience across master planning, housing design and healthcare sectors offers a unique set of skills in re-imagining the design and delivery of age-friendly homes.



# key terms

## **An Age-friendly Place**

“enables people of all ages to actively participate in community activities and treats everyone with respect, regardless of their age... a place that makes it easy for older people to stay connected to people that are important to them... helps people stay healthy and active even at the oldest ages and provides appropriate support to those who can no longer look after themselves.”

World Health Organization

## **The Third Age**

A life stage following retirement (or semi-retirement) where older adults are living generally healthy lives and are pursuing personal fulfillment.

## **The Fourth Age**

A life stage where older adults experience reduced mobility and / or develop greater dependence on others for care and support.



# global ageing trends



## later retirement

Ageing populations are putting pressure on pension provisions, which is impacting the age of retirement, older people's financial security and the affordability of appropriate housing. Many older people are having to balance the financial pressures of later retirement alongside chronic health conditions and caring responsibilities.



## rise in 85+ Cohort

At a global level, the 85-and-over population is projected to increase 351% between 2010 and 2050. Many countries are likely to experience a doubling of their 85+ population over the next 25 years, which will escalate the demand for long term residential care. (Source: [WHO](#))



## rise in living alone

The largest projected population increases are in older single-person households. This disproportionately affects women, who are currently twice as likely to live alone as men. Social isolation can have an acute impact on mental health as well as worsening a range of physical health conditions.



## unsuitable homes

A high percentage of older adults live in mainstream housing which may be unable to meet their health and mobility needs as they age. Poor-quality housing contributes to chronic conditions, while homes located a long way from local services and public transport links can trap older people who are unable to drive.



## chronic health conditions

The gap between life expectancy and healthy life expectancy is growing. We are seeing a rise in chronic conditions such as respiratory and cardiac illnesses, diabetes, cancer and dementia which is reducing the quality of our lives and putting greater pressure on global healthcare systems.



## changing family cultures

Changing trends include the role of women in society, declining birth rates, divorce and separation, and families living much further apart. These trends are altering the care dynamic between generations, resulting in greater risk of social isolation and a rise in demand for care provision.



## increased life expectations

Medical advancements and living standards have extended life expectancy with post-war generations having higher expectations for travel, healthcare and overall activity in their third age.

# regional perspectives



## North America

A report by the Government of Canada on Housing Needs of Seniors found that almost a quarter of senior households are living below housing standards for adequacy, affordability and suitability because it is increasingly difficult to find housing that meets their changing needs. (Source: [Housing Needs for Seniors](#))

Canada's older adult population (aged 65 and over) will increase by 68% between 2017 and 2037, (from 6.2 million to 10.4 million). (Source: [Canadian Institute for Health Information](#))



## UK

Age-friendly housing supply is lagging behind demand. It is estimated that at least 30,000 purpose-built age-friendly units are required every year until 2040 to meet demand. Only 8,000 are being built annually at present. (Source: [Home for later living report](#))

Recent UK housing policy has tended to promote the development of homes for first-time buyers, with limited focus on increasing the supply of age-friendly housing. Residential development in many town and city centres has been focused on models such as student living and private rented sector, which are also targeted at younger age groups.



## Asia

Asian populations will grow old at a faster pace than any other region in the coming decades, giving rise to concerns that emerging economies could see growth stall before they transition into high income status.

Cultural expectations that care for older adults be provided at home or by the community are more pronounced in Asia. In almost all Southeast Asia nations, 60-80% of older adults live with their children. (Source: [Asian Post](#))

# age-friendly living

Age-friendly living is an umbrella term that describes housing designed to be accessible (barrier-free) and enable people to live independent, fulfilling lives as they grow older. These models offer independently accessed apartments, often with additional communal facilities or support services attached.

High-quality, age-friendly housing offers wide-ranging benefits to older people and wider society. These include:

- Addressing the social and physical isolation that many older people face.
- Increasing choice of where and how people want to live in later life.
- Aiding the transition from third age to fourth age, with the aim of reducing the number of 'crisis' moves into long-term residential care institutions.
- Avoiding the need for costly and disruptive mobility adaptations to existing homes.

Governments around the world have begun to recognize some of these benefits, particularly the role of age-friendly housing in mitigating the risk of future care costs.

We recognize that older people's needs vary according to different markets, contexts and cultures, and a key part of this is to offer a range of affordable choices.

This report takes a fresh look at the issues related to the design of age-friendly housing and the relationship between older people and our towns and cities. This includes:

- A focus on underutilized urban locations and sites.
- Homes that are integrated into a wider urban neighbourhood.
- A flexible approach to scale and density that is suited to a mixed-tenure, mid-market offer.
- A lightweight approach to communal space and facilities, recognizing the impact on the viability of these spaces.
- Rethinking the role of the building management as facilitators who can act as a link between residents and the wider community.



# design framework

The design framework is structured around two interconnected concepts: the age-friendly neighbourhood and the age-friendly home.

The linking of home and neighbourhood is important in terms of looking beyond the site boundary and considering how age-friendly developments can form part of a sustainable and resilient urban strategy. Examples such as the '15 minute city' and 'lifetime neighbourhood' have been used to describe the benefits of an interconnected network of social and physical resources within a local urban area.

In structuring the framework around these neighbourhood-based examples, we recognise that some of these criteria are outside the control of the designer, developer, or urban planner.





# location framework

General trends show movement away from urban centres when people move through the different stages of their lives. As we reach later life, living at the fringes of towns and cities combined with poor public transport can hinder access to services and support.

This movement pattern outwards from the centre is not the only possibility.

Town or city centres across the world are facing huge changes, including the shift away from retail and commercial uses towards more mixed-use residential communities. This offers the next generation of older people the benefits of living within a denser, more connected location that can provide a wide range of amenities and care provisions.

These concepts are currently being explored by planners around the world who are seeking to create sustainable towns and cities that offer employment, leisure, retail, green space and homes within a compact urban neighbourhood.

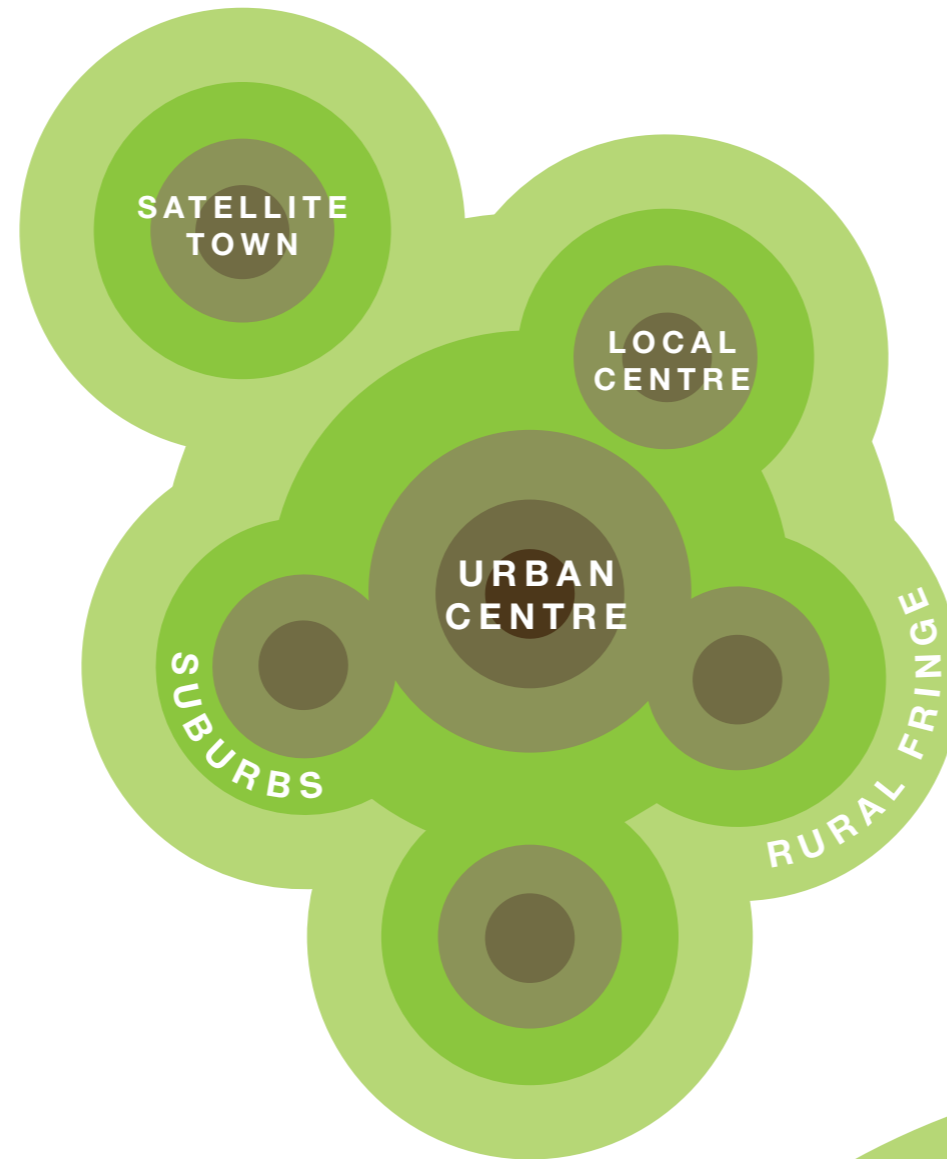

## Key urban trends

- The contraction of urban retail cores offers opportunities for diversification.
- The impact of the Covid-19 pandemic on future demand for office space and commuting.
- Continued global demand for new housing (intensification versus rural fringe expansion).
- An ageing population, with increased demand for health and care services.
- An increasing trend of people in their later life becoming isolated from services and support in lower density areas with poor public transport.
- Social atomization of extended families = weaker local support networks.

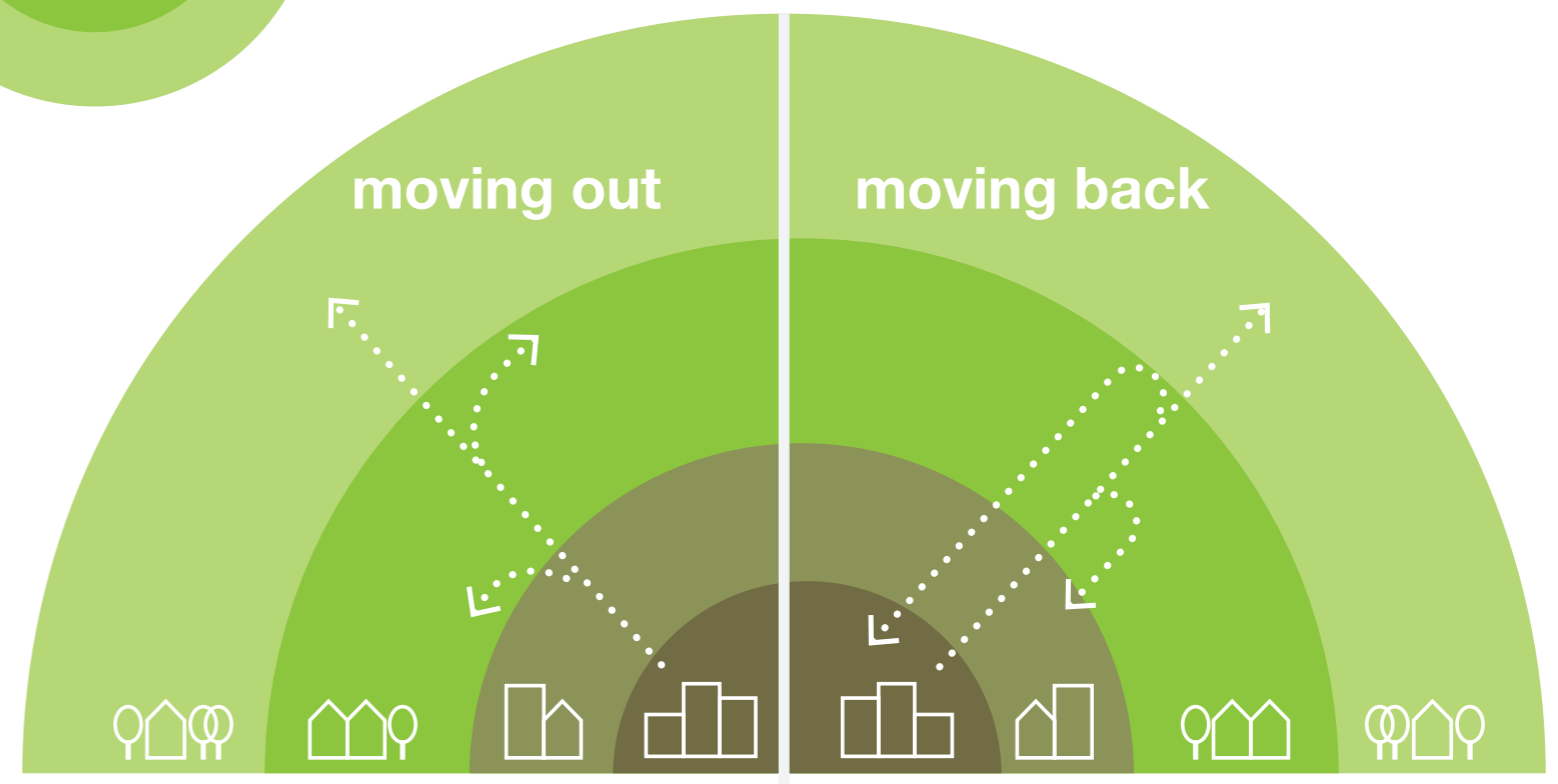

People have tended to move away from urban centres as they start families and grow older

Older households are being attracted back to attractive urban centres that offer access to amenities and social life

# economic framework

For many people reaching the age where age-friendly living and care support is needed, the senior or retirement housing options currently on offer are likely to be unaffordable, undesirable or unobtainable. The lack of affordability and choice can have a huge impact on older people's wellbeing, particularly if they become 'trapped' in inappropriate homes. A common scenario that faces many older people is prolonged hospitalisation or a 'crisis' move into residential care due to the inaccessibility of their home environment.

Cost effective ways of designing and delivering age-friendly housing is critical to expanding opportunity and choice for a broader population. Our economic framework explores three key areas where design can play a role in making age-friendly living more affordable.

## opportunities to optimize costs through design

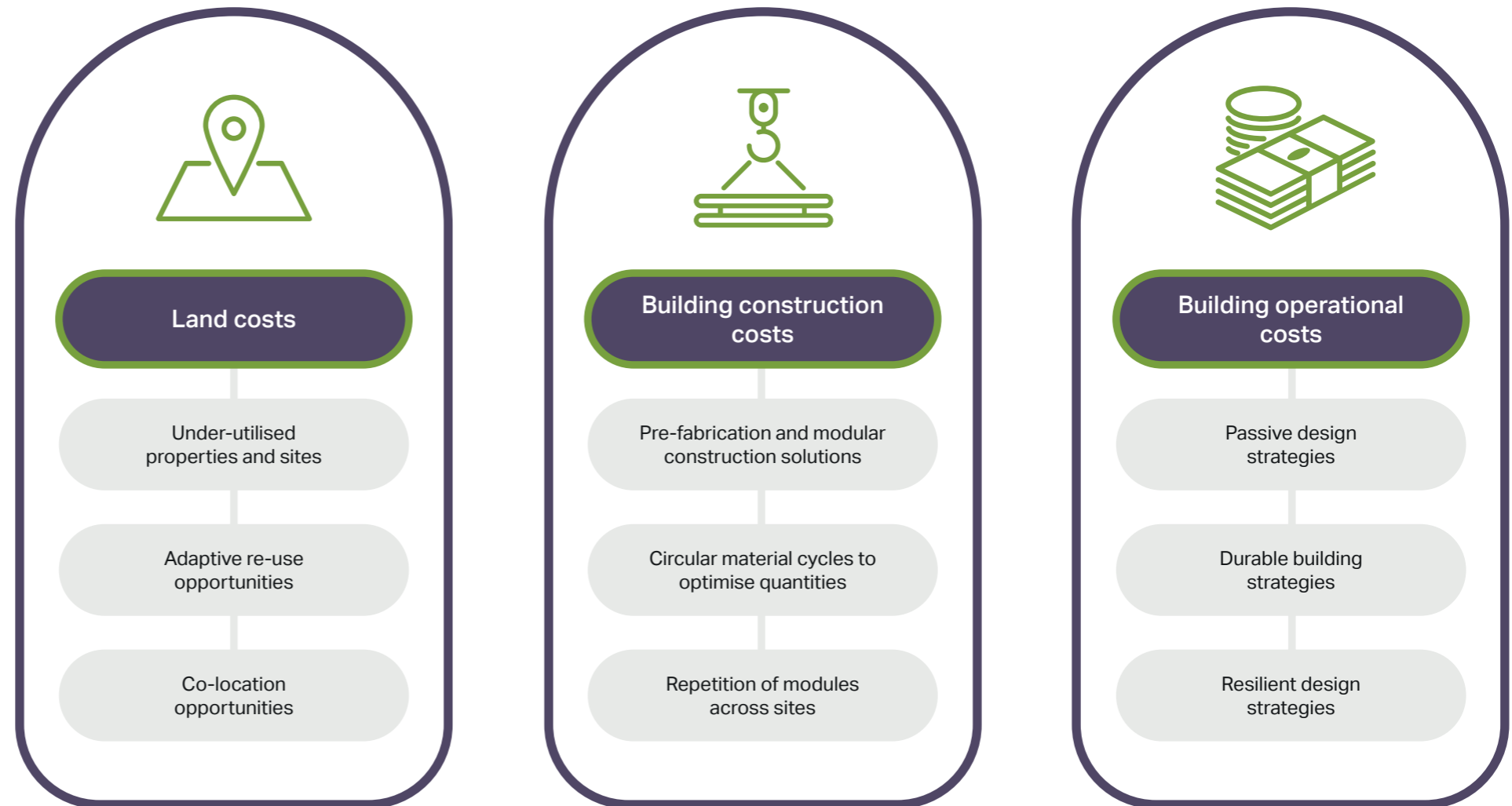

A blurred architectural rendering of a modern building with a courtyard. The building has a grid-like facade with large windows and brick accents. People are shown walking and sitting in the courtyard, which is landscaped with trees and walkways. The overall scene is bright and airy, suggesting a high-quality, modern living or working environment.

# **design** concepts

# design concepts

1

## Balance of personal, social and community space

Relocating in later life needs to be an attractive proposition - generous private living and outdoor space, a sense of privacy and security, and a range of social and community facilities at your doorstep.



3

## Revitalization and intensification of urban centres

The role of town and city centres is rapidly evolving - we believe that age-friendly living can play a key role alongside other types of residential development to revitalize urban centres.

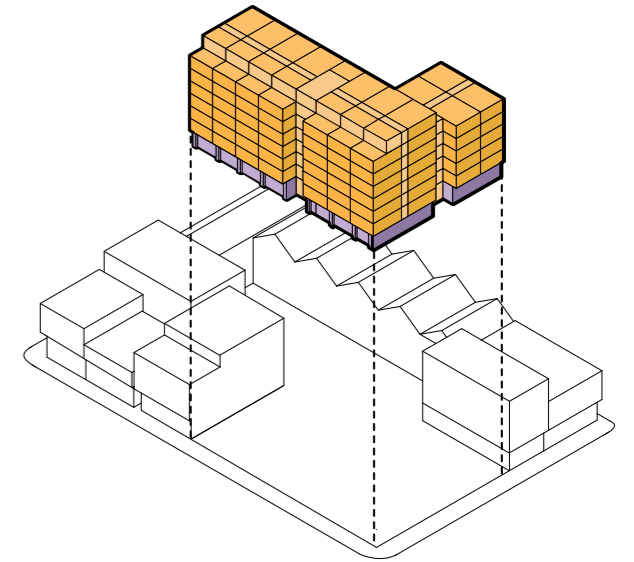

2

## Connecting with the neighbourhood

This approach looks at location, scale and use, reimagining age-friendly living as connected to a wider context and community.

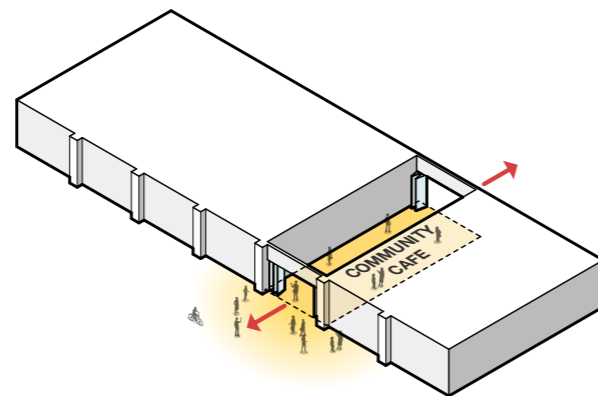

4

## Modular design and construction

Starting with a modular/off-site concept offers economies in both the design and construction process, providing a safer and more economical way to build.

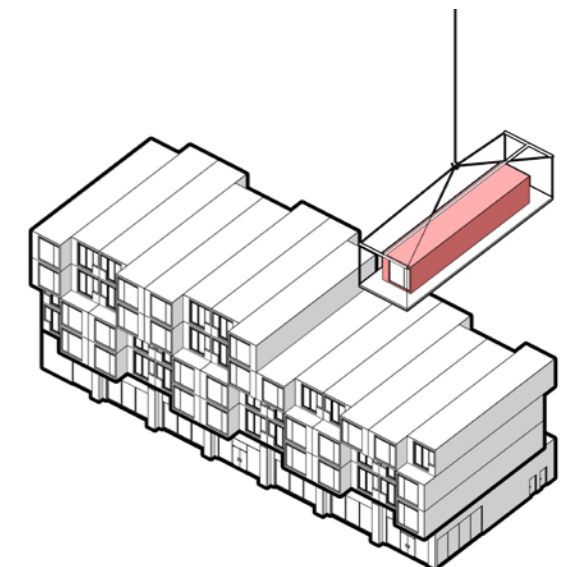



1

**design concept**  
balance  
of personal,  
social and  
community  
space



Community cafés and other public facilities should be designed to be open, bright and welcoming, providing an attractive frontage onto the public realm.

Image: Mulberry Park Community Hub, Bath

# 1 balance of personal, social and community space



## personal space

- Own front door
- Accessible bathroom and kitchen
- Integrated storage
- Daylight and views
- Generous balcony
- Secure access



## social space

- Social circulation space
- Distributed sun rooms
- Events space
- Exercise / gym facilities
- Gardening space



## community space

- Community café
- Outdoor eating and drinking
- Community events
- Retail and other amenities on the doorstep
- Access to transport networks
- Access to local green space

# 1 balance of personal, social and community space

## personal space / UK and North America

Our living area provides an accessible layout with flexible amenity spaces to host guests. Generous glazing and balconies allow for plenty of daylight and views to nature and the local neighbourhood.

Developments should typically include a mix of 1-bed and 2-bed modules to provide choice and flexibility.

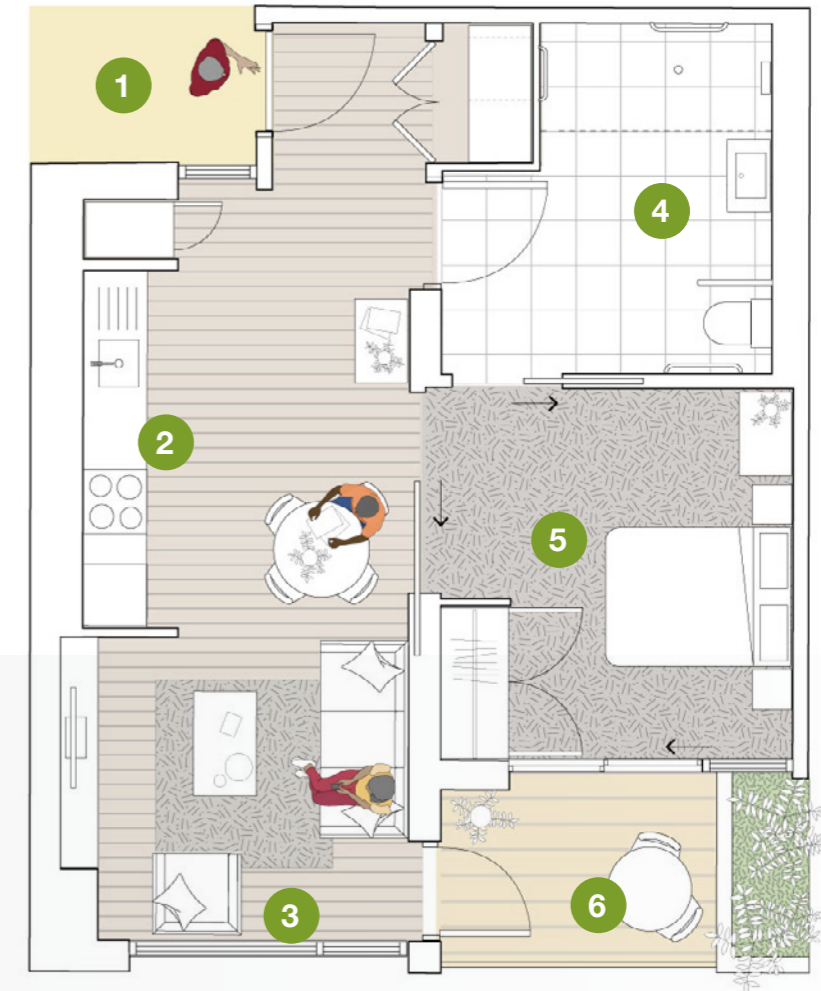
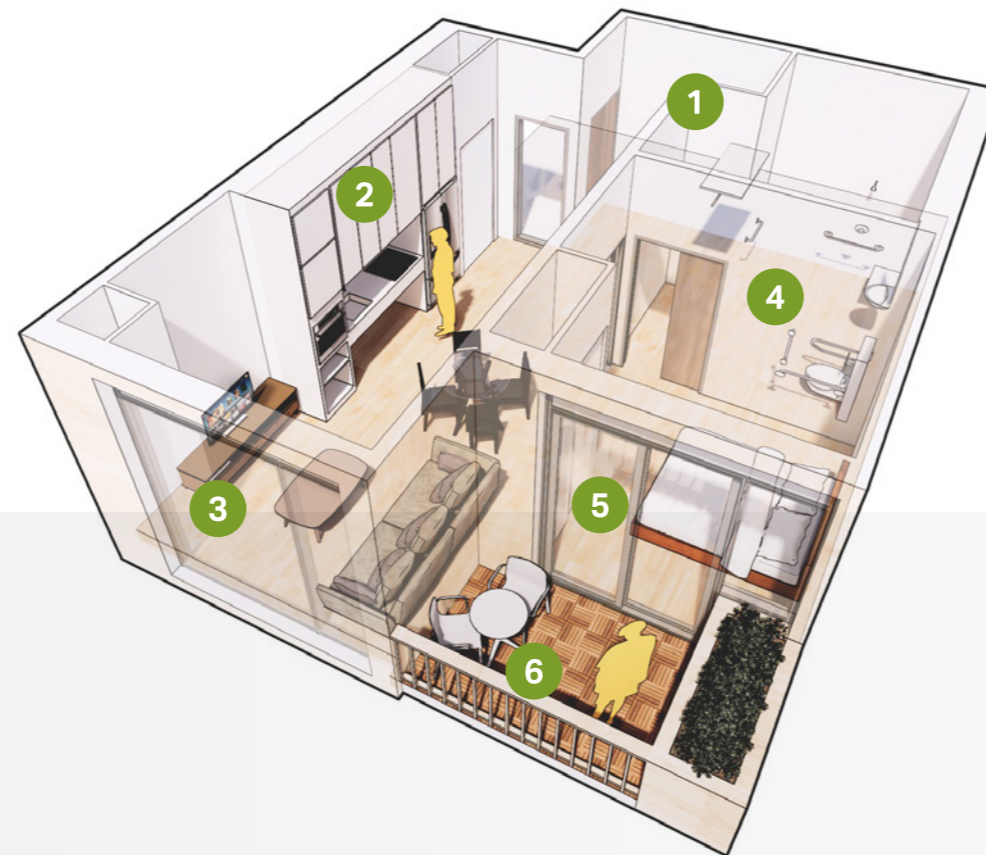

1

### shared porch

- semi-private alcove in corridor for social connection
- sidelight providing daylight to corridor
- entry nook with closet

2

### kitchen

- accessible features
- potential for wheelchair accessible oven / sink
- accessible cupboard spaces

3

### living / dining

- daylight and views to nature and active neighbourhood
- open-plan
- spacious enough to host and entertain friends

4

### bathroom

- low maintenance, integrated features
- roll-in shower
- direct link to bedroom

5

### bedroom

- daylight and views to nature and active neighbourhood
- direct access to private balcony
- proximity to bathroom
- sliding doors allow space to be opened up during the day

6

### balcony/terrace

- views to nature and active neighbourhood
- pocket garden



# 1 balance of personal, social and community space

## personal space / Southeast Asian

In almost all Southeast Asian nations, more than 60% of older adults live with their children because it is culturally expected that care for older adults be provided at home or by the community. This concept looks at two-generation and three-generation living apartments with bedrooms and bathrooms designed as modular units to facilitate efficient construction and work site productivity.



### Key

- |                   |                   |            |
|-------------------|-------------------|------------|
| ① studio bedroom  | ⑤ living room     | ⑨ bedroom  |
| ② ensuite kitchen | ⑥ kitchen         | ⑩ bathroom |
| ③ bathroom        | ⑦ master bedroom  |            |
| ④ balcony         | ⑧ master bathroom |            |

# 1 balance of personal, social and community space

## **social space** / residences

Each floor acts as a neighbourhood or cluster. Much like a city block, semi-public spaces are provided for each suite for neighbours to sit and socialize in pairs or larger groups. These areas include both visual and physical connections to nature.



## **shared porch**

Recessed nooks at the entry into each pair of apartments create semi-private porch spaces along the corridor that can be personalized by residents.

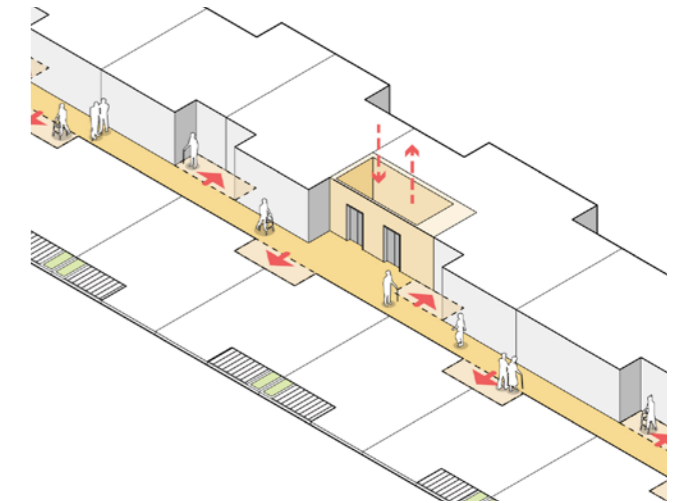

## **cohort lounge**

An informal social space is created adjacent to the lift core on each floor for small gatherings.

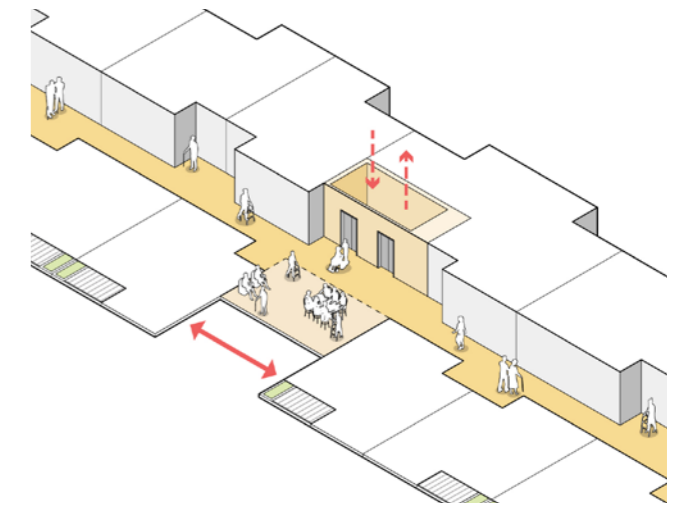

## **outdoor gathering**

A terrace is provided adjacent to the lounge for smaller outdoor gatherings to serve each cluster.

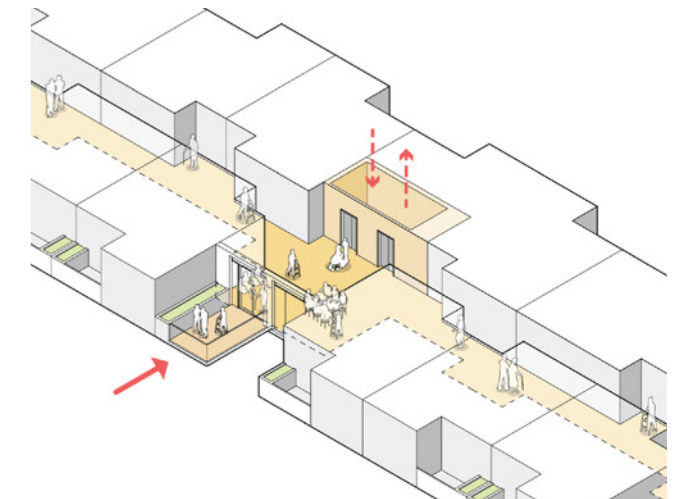

# 1 balance of personal, social and community space

## social space / rooftop

Access to the outdoors is key to good health and wellbeing. Gardening provides opportunities for both mental and physical exercise through planning and tending the garden. Shared hobbies encourage people to connect through activity and story telling.



## create

Set back top floor to create a generous terrace.

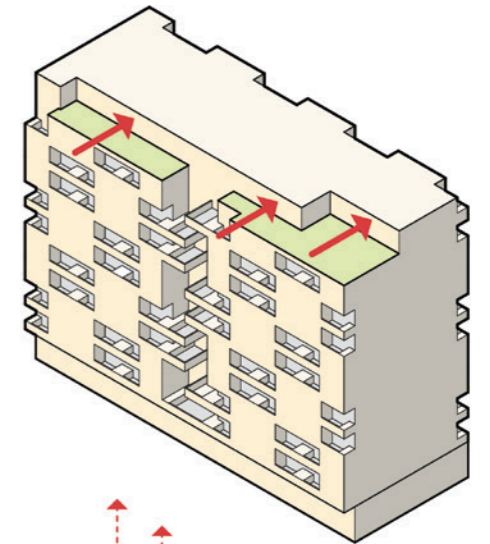

## sculpt

Create pitched roofs to accommodate skylights and photovoltaic arrays.

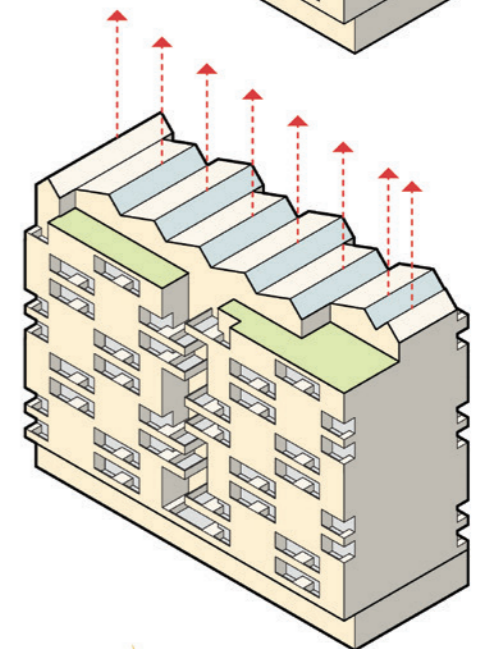

## animate

Add trellises, garden plots and lounge furniture.

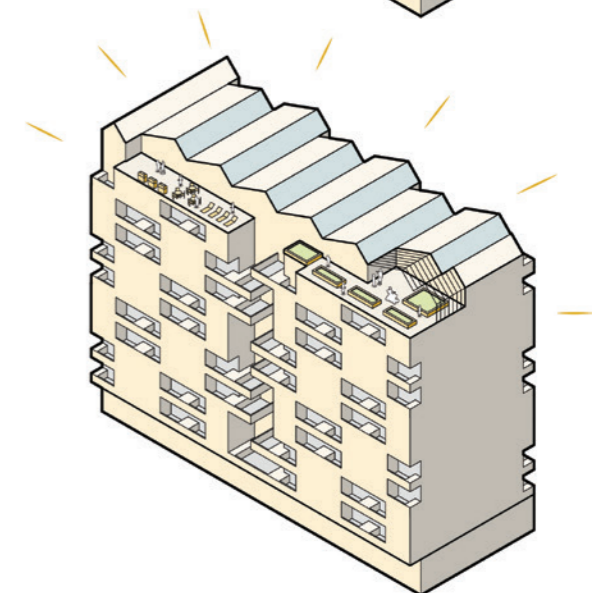

# 1 balance of personal, social and community space

## community space / ground level

The ground floor is the connection to the community. It has a flexible design to encourage a variety of age-friendly activities. Central to this shared community space is the facilitator whose role it is to organize activities and form the heart of the community.



## community café

The community café acts as a flexible hub for varied social activities and events throughout the year and changing seasons. It could be used as an exhibition or performance space during the winter and a farmers' market during the summer and autumn.

## shared services

Activity spaces, health service spaces and vertical circulation to the residential floors are located adjacent to the central community café.

## mixed-use

Retail, food or drink units occupy the remainder of the ground floor, complementing the shared services and further knitting the building into the surrounding community.

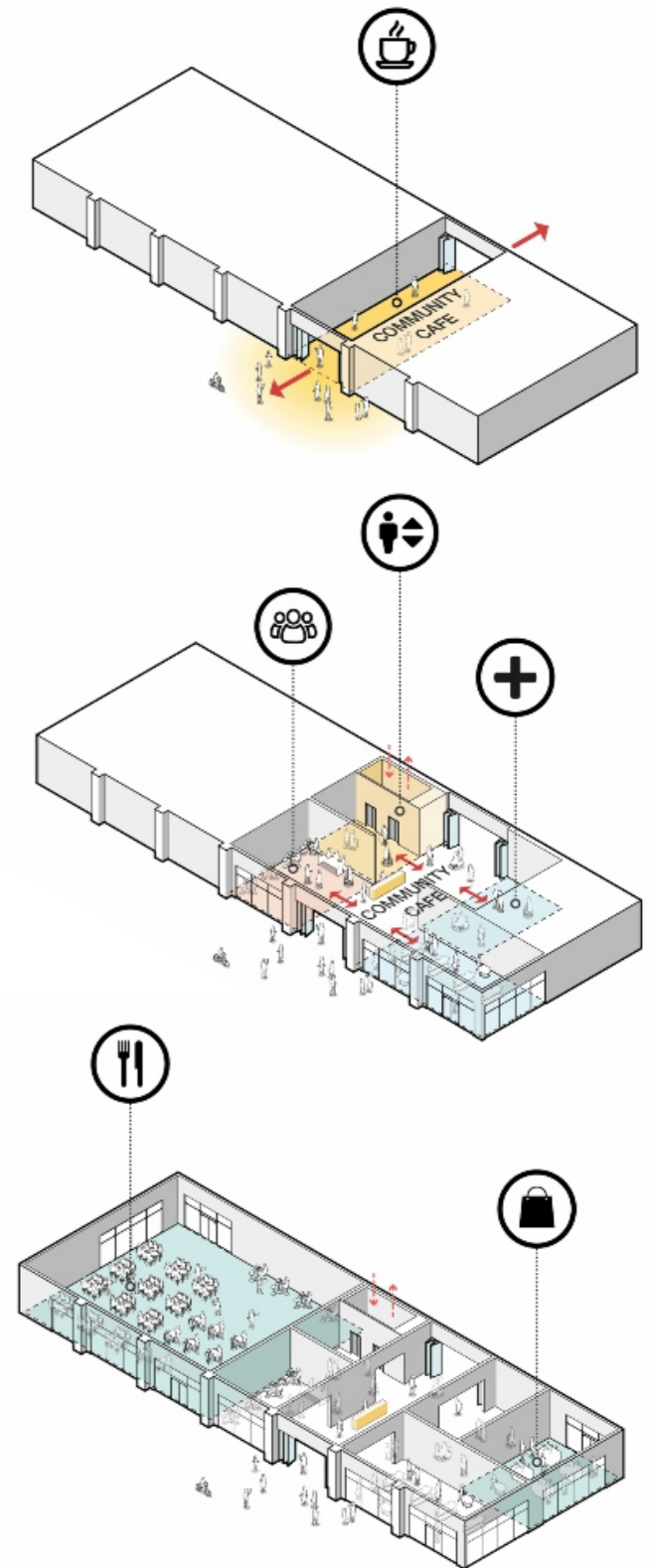

# pandemic conditions

The Covid-19 pandemic has disproportionately affected older adults across the world. We have seen greater hospitalization, an impact on wellbeing and higher mortality.

The risk of contagion was highly dependent on where a person lived and their interactions with others. In many parts of the world, people were isolated for their protection which lead to an increase in loneliness and mental health issues which subsequently increased the prevalence of physical issues.

Our age-friendly design concept incorporates key facilities and features that, in addition to daily living, would support older adults should we face ongoing restrictions or another pandemic in the future.

Key public and private thresholds enable community use and access whilst ensuring residents' security and privacy.

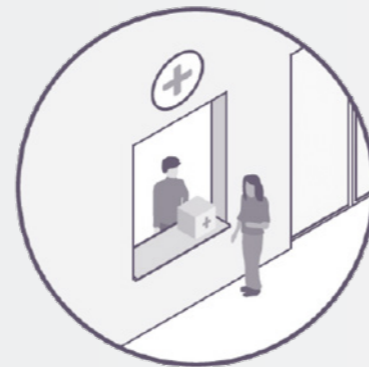
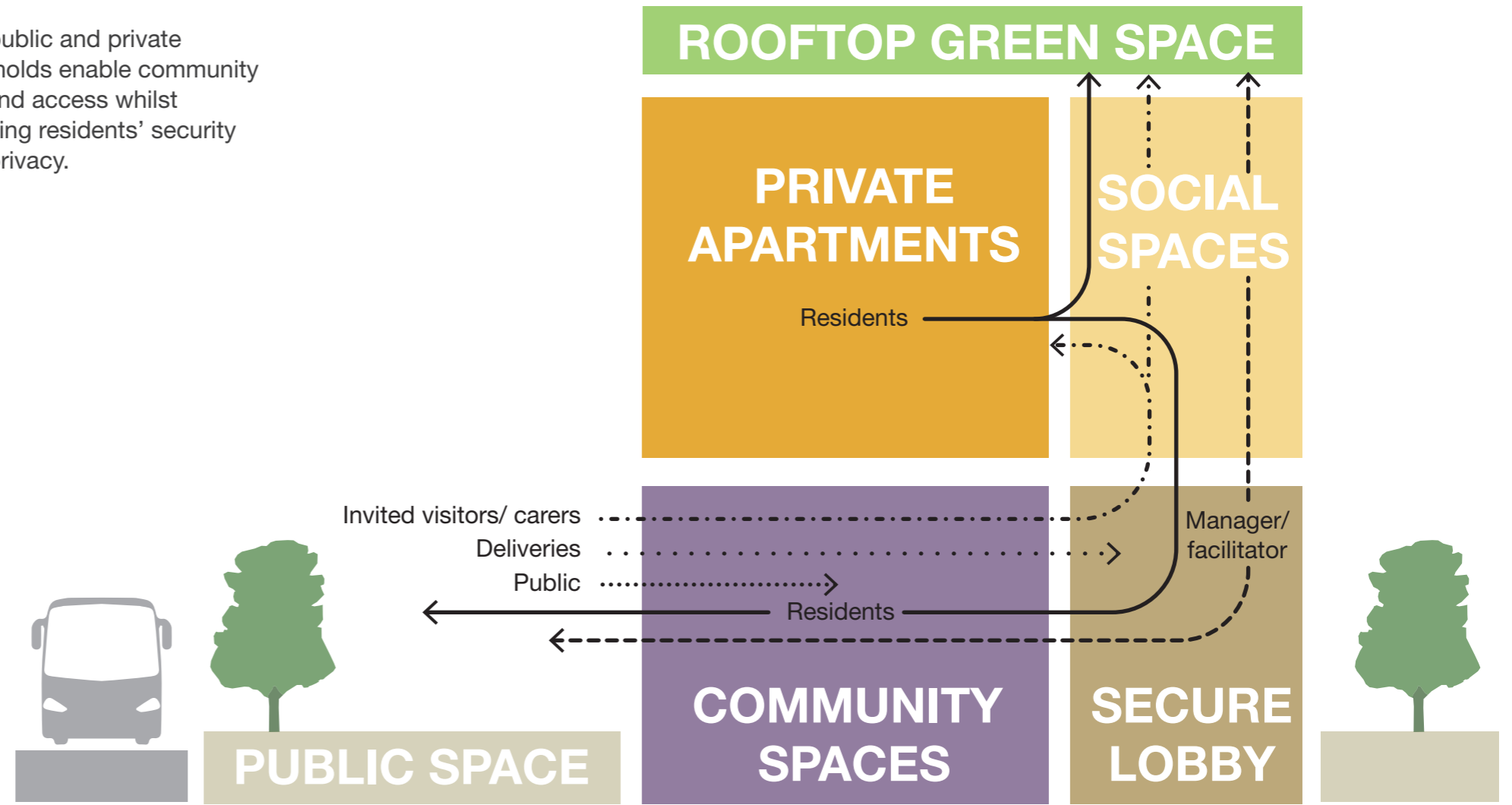

## pharmacy drop-off

A drop-off window will connect the ground floor pharmacy and the community café to fulfill prescriptions during a lockdown scenario.



## parcel delivery

Parcels for each resident, including medication, will be delivered to their porch by the facilitator to minimize external contact. Residents can also leave parcels in the porch for collection and postage.



## social space

During times of physical distancing the central social space will function as the cluster gathering area for the cohort of 10 units per floor.

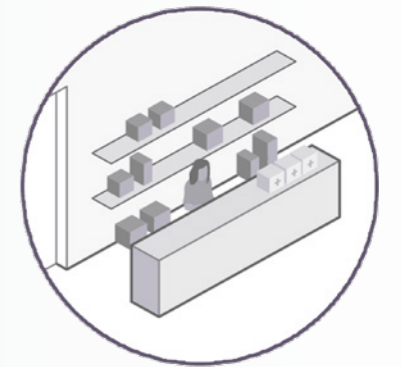

## facilitator

The building's facilitator acts as the touch point between residents and the outside world; collecting packages, medication deliveries and screening visitors.



**design concept**  
connecting  
with the  
neighbourhood



Louvred balconies allow summertime ventilation or can become passive solar winter-gardens in colder weather.

Image: Landsea Eco Housing, Nanjing, China

# 2 connecting with the neighbourhood

## UK / North America

Our mid-rise proposals seek to integrate the personal, social, and community spaces together into a coherent development proposal for urban and infill sites. The building form will need to adapt to the specific constraints of available plots, however the key relationship is between the building and the street. This includes a ground floor plinth with active uses centred around the community café concept.

Generous balconies and roof terraces provide much-needed outdoor space while reinforcing the connection between residents and their neighbourhood. This concept is supported by wider proposals to prioritize pedestrian, cycle and scooter movement, and introduce trees and planting to the surrounding streets and public realm.

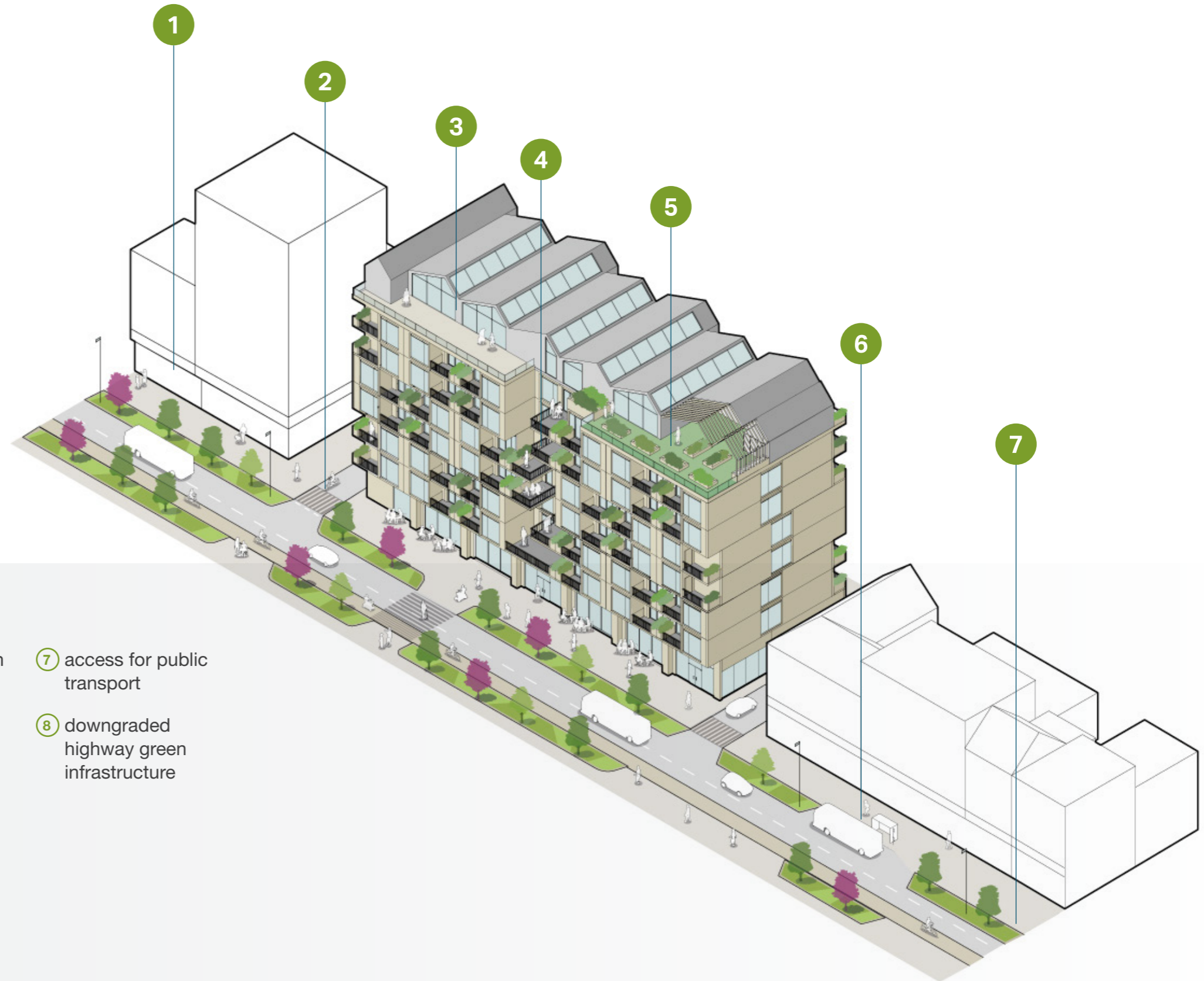

### Key

- ① studio bedroom
- ② access to local shops and amenities
- ③ pedestrian / cycle / scooter priority
- ④ active frontage with community facing ground floor uses
- ⑤ shared and private balconies
- ⑥ residents' shared roof garden
- ⑦ access for public transport
- ⑧ downgraded highway green infrastructure



# 2 connecting with the neighbourhood

## Southeast Asia

One of the advantages of high-rise mixed-used residential developments is that they support the provision of varied commercial, civic and transport amenities in close proximity to homes making them ideally suited to older generations.

Networks of sheltered pathways and bicycle lanes improve mobility and accessibility whilst promoting sustainable and affordable transport. The retail podiums within mixed-use developments provide easy access to localised amenities like supermarkets, coffee shops and kindergartens alongside community facilities.

With land becoming scarcer in most Southeast Asian cities, sky gardens and terraces provide open spaces where older residents can meet family and friends, exercise or pursue recreational activities. Whereas pockets of green spaces on the ground level and podium roof can be used for community farming or outdoor events.

### Key

- ① retail podium
- ② community farming
- ③ 4-bed multi-generational unit
- ④ skybridge with viewing deck
- ⑤ sky terrace with residential amenities
- ⑥ retail and community programs
- ⑦ multi-generational playground

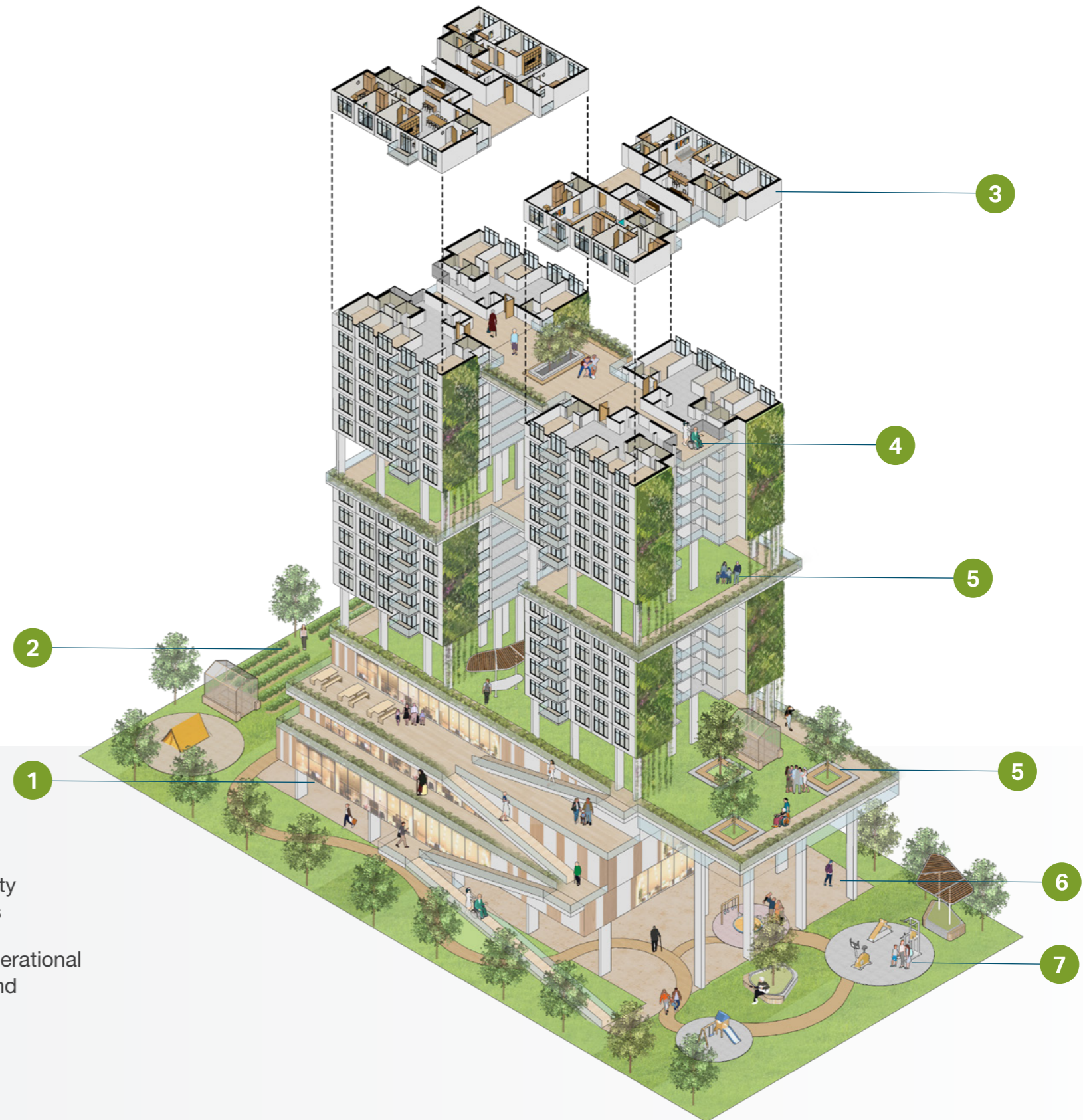



3

**design concept**

revitalization and  
intensification of  
urban centres



Mixed-use residential developments offer active public frontages, whilst supporting diverse and unique local businesses.

Image: DUKE, Toronto Canada (BDP Quadrangle)

# inclusive communities

Mixed-use urban intensification offers the 'win win' scenario of creating sustainable, multi-generational communities while supporting an ecosystem of businesses and services.

To realize the benefits of urban intensification, places must be able to attract a wide range of residents, including older people. This requires careful consideration of future residents and their social, cultural and economic infrastructure as much as the buildings themselves.

As people anticipate the transition from third to fourth age, the local neighbourhood becomes an increasingly important place to shop, socialize, and access amenities and services. Ensuring that new, age-friendly developments are considered alongside their neighbourhood context is crucial to expanding this type of housing within urban centres.



## mobility

- Streets that are accessible for all, including for those with disabilities.
- Joined-up cycle and mobility scooter networks.
- Housing located with access to public transport networks.

## amenity

- Local retail, services, cafés and food outlets created as part of mixed-use development.
- Provision of community healthcare facilities such as pharmacies and drop-in centres.

## community

- Employment, volunteering and lifelong learning opportunities within the immediate area.
- Facilities for formal and informal sport and recreation.
- Space to host social groups and organizations.

## outdoor

- Green streets with trees, integrated planting and biodiverse pockets.
- Access to biodiverse places.
- Community gardens and opportunities for larger-scale gardening.

## comfort

- Consideration of low emissions zones / car-free streets, particularly where natural ventilation or balconies are proposed.
- Appropriate zoning of late-night uses to avoid noise issues.
- The design of safe streets and places.

# 3 revitalization and intensification of urban centres

## town centres / UK

In the UK, many high streets and urban centres are failing due to poor investment and a transition to online retail. In 2020, research by PwC found that whilst 5,119 shops had opened, 11,200 shops had closed. This demonstrates the continued decline in 'brick and mortar' stores across the country, leaving a vast range of buildings empty in our town centres.

Increasing density through age-friendly residential developments, alongside a mixture of other uses such as workplace, retail and community facilities can help to bring back vitality and footfall to our town centres. For older adults, it enables them to live in the heart of the community with easy access to amenities and transport.

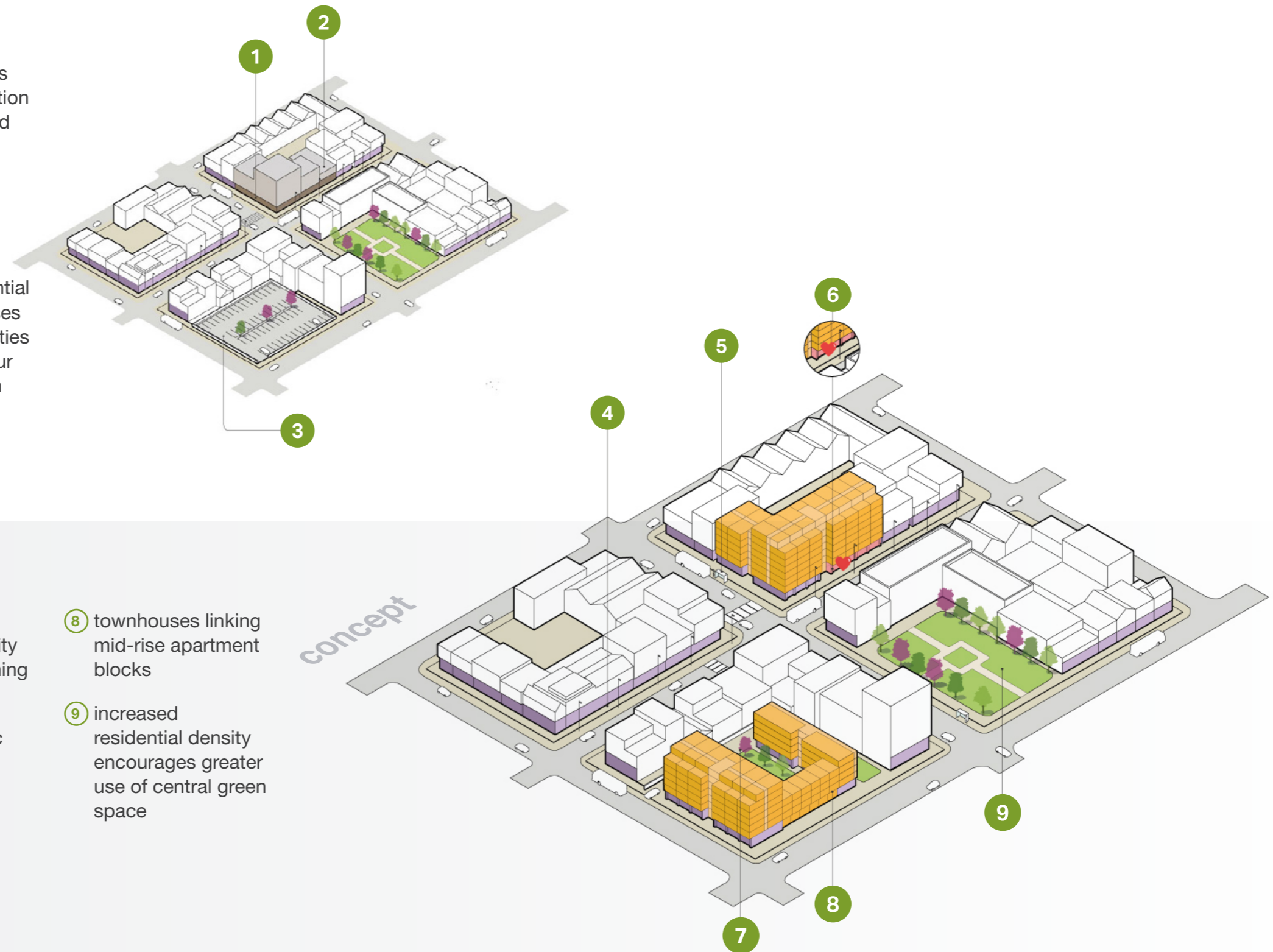

### Key

- ① large redundant units along the high street
- ② redundant upper floors of existing buildings
- ③ underused surface car park
- ④ increased residential density supports remaining high street retail
- ⑤ access to public transport
- ⑥ community café
- ⑦ vehicle/service access below podium garden
- ⑧ townhouses linking mid-rise apartment blocks
- ⑨ increased residential density encourages greater use of central green space

# 3 revitalization and intensification of urban centres

## city centres / Southeast Asia

Vertical density can solve problems associated with rapid urbanization and land scarcity, but can also lead to citizens feeling disconnected from their communities especially within the older generations. Incorporating sky gardens and sky terraces throughout high-rise developments alongside other communal facilities like cafés can provide nearby spaces where family members and neighbours can socialize and feel a sense of community.

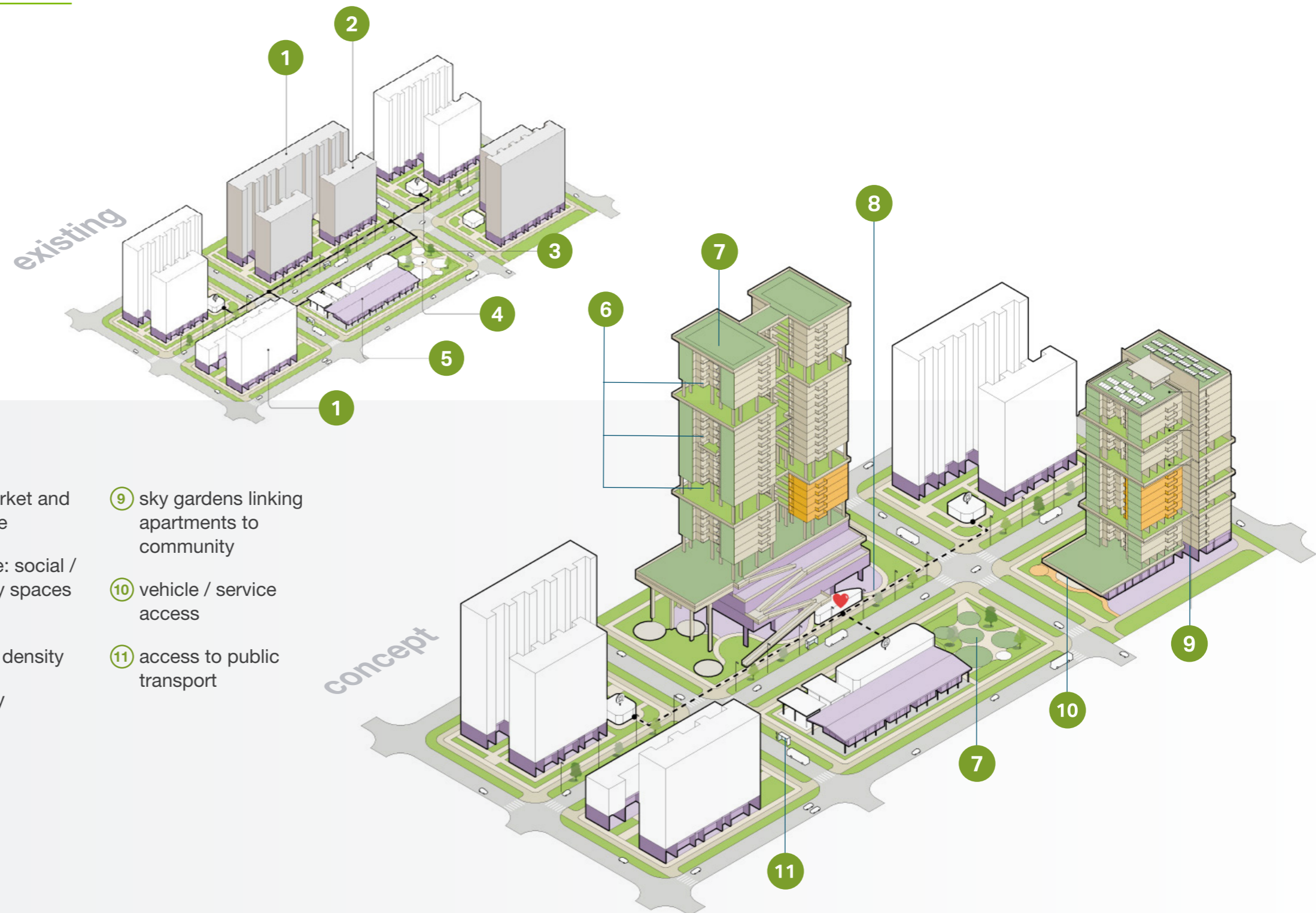

### Key

- ① existing mid-rise mixed-use blocks
- ② underused roof of existing buildings
- ③ at-grade route to train station
- ④ underused central green space
- ⑤ district market and food centre
- ⑥ sky terrace: social / community spaces
- ⑦ increased residential density
- ⑧ community café / hub
- ⑨ sky gardens linking apartments to community
- ⑩ vehicle / service access
- ⑪ access to public transport

# 3 revitalization and intensification of urban centres

## suburban malls / North America

In recent years, due to the popularity of online shopping, property owners have diversified by transforming their malls into leisure destinations, by adding non-retail amenities such as entertainment attractions, fitness centres and food markets.

The next evolution for mall sites is to become all-encompassing community hubs. A [study](#) by the Retail Council of Canada found that 87% of Canadian adults say they would consider residing in 'live, work, shop, play' environments.

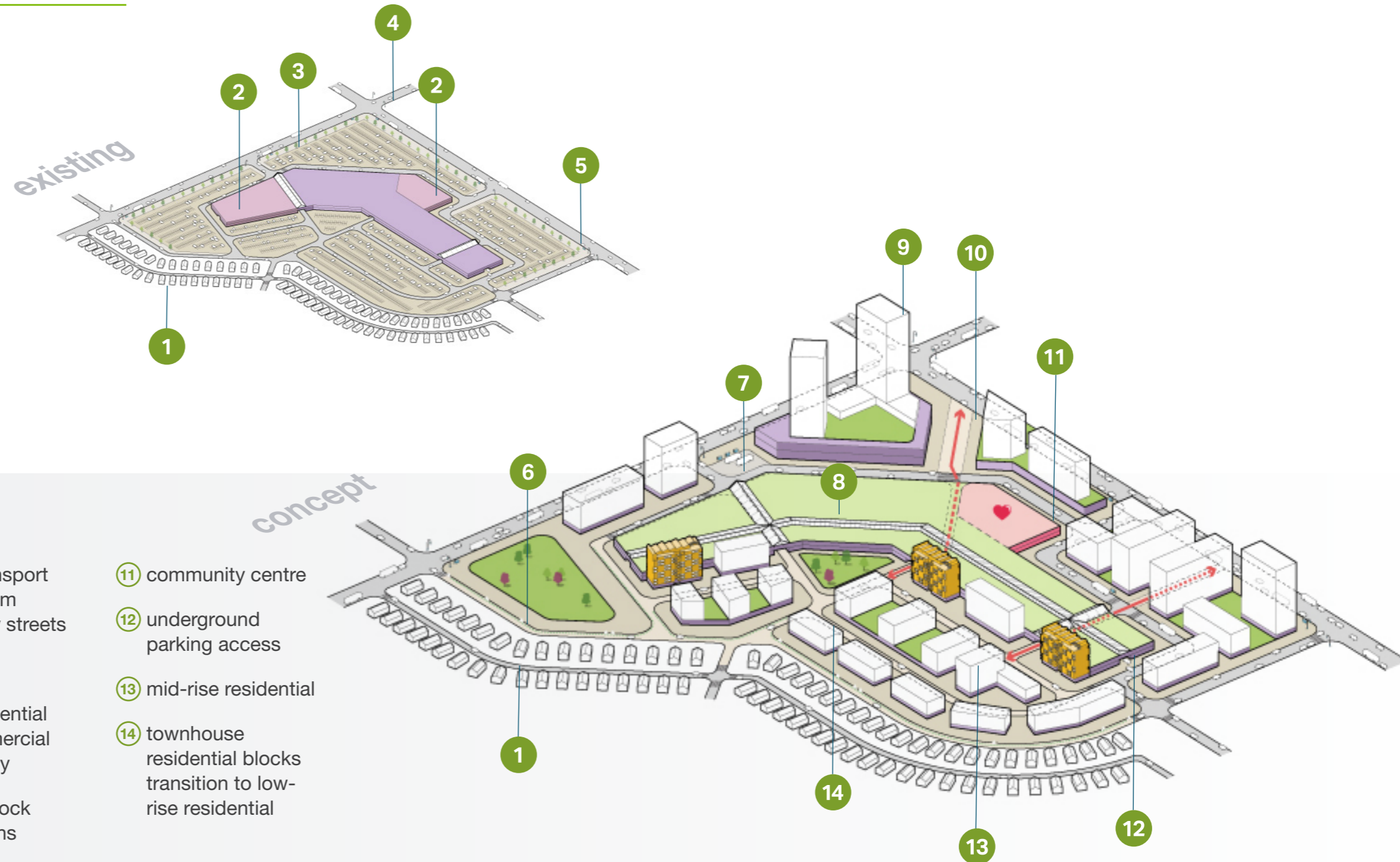

### Key

- ① existing neighbourhood
- ② anchor tenant
- ③ public transport
- ④ major intersection
- ⑤ surface carpark
- ⑥ pedestrian oriented streets
- ⑦ public transport access from secondary streets
- ⑧ green roof
- ⑨ main residential and commercial opportunity
- ⑩ through block connections
- ⑪ community centre
- ⑫ underground parking access
- ⑬ mid-rise residential
- ⑭ townhouse residential blocks transition to low-rise residential

**design concept**

prefabrication  
and modular  
construction







Modular design can create quality apartments delivered on a tight budget, with smart solutions such as services pods to speed up construction.

Image: Abito, Manchester, UK (BDP)

# 4 prefabrication and modular construction

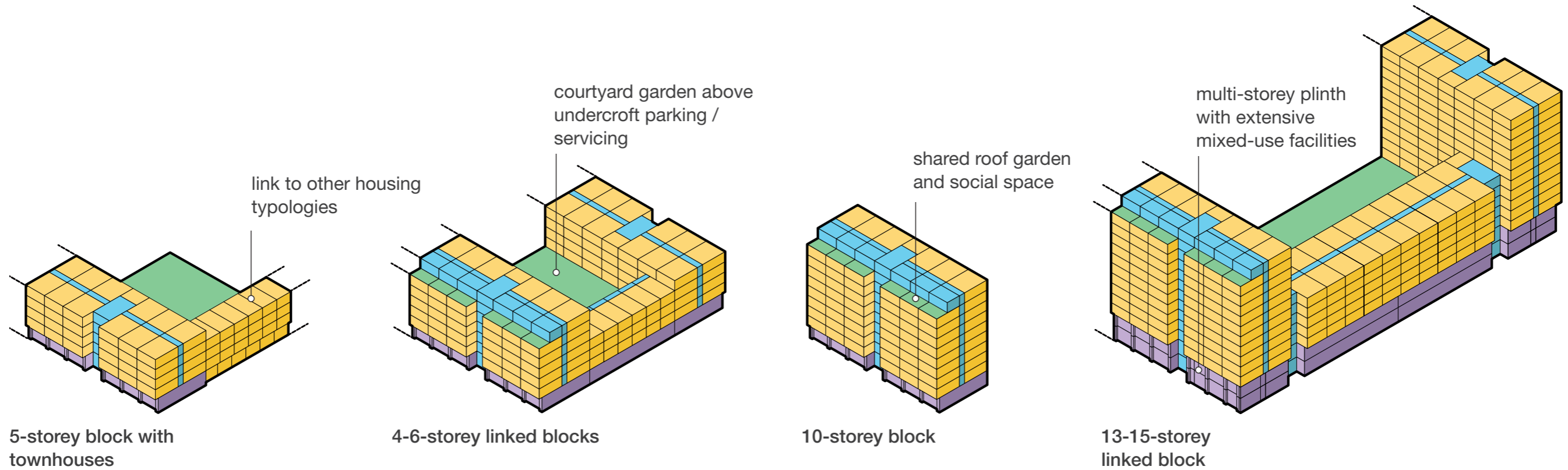

In recent years, there has been a renewed interest in the use of modular and off-site construction methods for taller buildings, particularly in the residential sector where there is significant repetition in layout and servicing requirements.

Cost savings are achieved through the efficiencies of repeating modules across a building or multiple building sites and streamlining the material procurement process by providing more control over quality, sourcing and waste. To realize these savings, the project must be coordinated in detail much earlier in the design process using an integrated BIM management. A manufacturer should be included as part of the design team from concept stage, working through an iterative design process to realize available efficiencies.

For the construction industry, modular and off-site provides a safer and more accurate working environment because the modules are constructed, on the ground and in a weather-protected environment. This allows modules to be fabricated while site preparation and foundation work is underway, shortening the construction timeline and reducing site disturbance for the nearby community.

## Key

- Age-friendly apartments
- Circulation / social spaces
- Shared greenspaces
- Commercial / healthcare

# 4 prefabrication and modular construction

The modular method shown here uses an existing volumetric modular steel system. This concept can also be applied to other less carbon intensive systems such as mass timber.

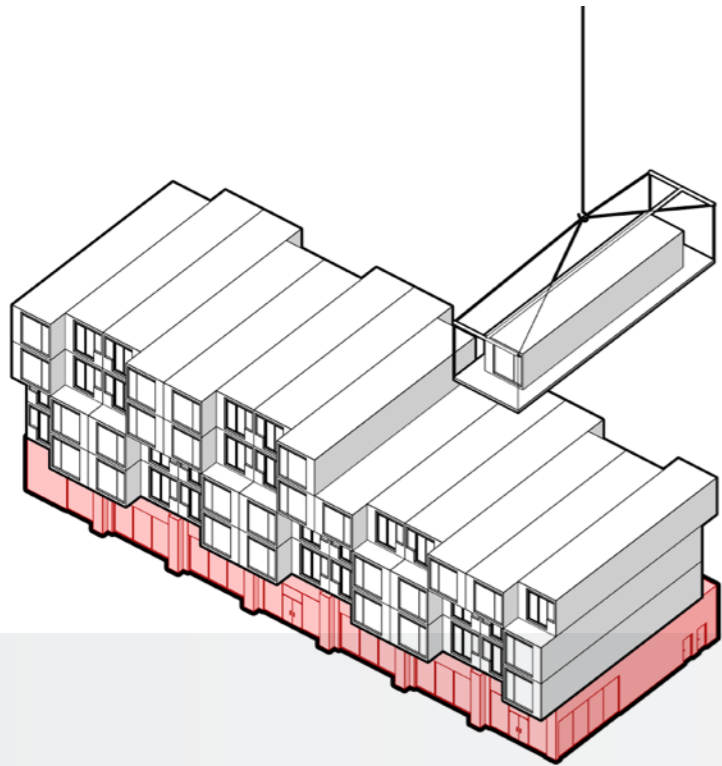

## ground floor

The ground floor is built using load-bearing construction (e.g. poured concrete) to provide a platform for the upper floor structure to be fixed too. Consideration should be given to aligning the ground floor footprint with the upper floors to maximize structural efficiency.



## mid-rise developments

Depending on certain design variations, modular buildings can typically be constructed up to 15-20 storeys without additional support.

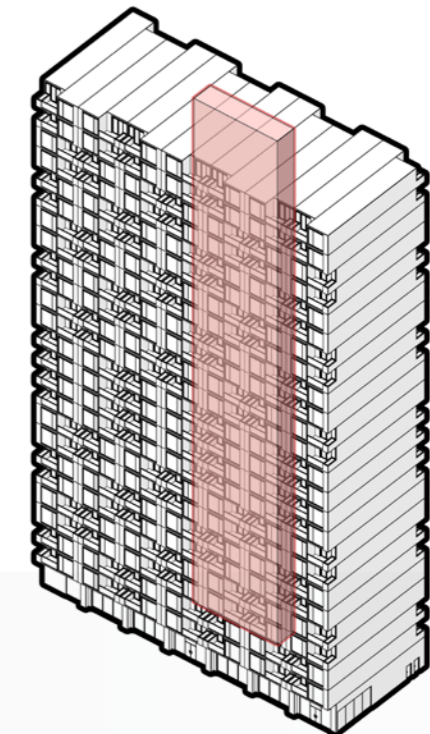

## high-rise developments

Above 15-20 storeys the structure needs to be enhanced with a secondary system such as a concrete core or steel superstructure, which adds costs to the project.

# age-friendly conclusion

As a society, we are facing an ageing population where the number of people aged 65 or older is expected to triple by 2050 (Source: WHO). However, the built environment has yet to fully respond to the urgent demand for attractive, affordable, well-connected age-friendly homes and communities that can meet the diverse needs of older adults.

The intention of this report is to generate discussion and engagement with organizations who wish to develop design solutions for high quality age-friendly housing by sharing our ideas on how:

- We can transform underutilized sites in our urban centres into inclusive, multi-generational neighbourhoods.
- We can design housing that supports the transition from third age to fourth age living by applying a framework focused on age-friendly living.
- Smart design and construction techniques can deliver cost effective, efficient quality buildings.

Our experience shows that creative thinking through collaborative partnerships can overcome long-standing challenges and deliver maximum impact, so if you would like to work together on exploring ideas or opportunities for age-friendly housing, please get in touch.

*We would like to thank Dr. Mark Lachmann, Sinai Health and Emanuel Resendes, EllisDon Modular for taking the time to share their knowledge with us.*



# North America

## **Ken Brooks**

Design Director  
kbrooks@bdpquadrangle.com

## **Michelle Xuereb**

Director of Innovation  
mxuereb@bdpquadrangle.com

## **Jesse Klimitz**

Director of Human Space  
jklimitz@humanspace.ca

# UK

## **Stephen Marshall**

Architect Director  
stephen.marshall@bdp.com

## **Adam Park**

Architect Associate  
adam.park@bdp.com

# Asia

## **Jeremy Farrington**

Architect Director  
jeremy.farrington@bdp.com

## **Andrew Loke**

Architect Director  
andrew.loke@bdp.com